

RFX



THERMAL
IMAGING SCOPE
DBH D12

User Manual V1.2



Please inspect your batteries for any external damage before charging.

Please make sure you fully charge your batteries before use.

Do not point at the sun and/or high heat sources.



We appreciate you choosing RIX.

Please read the instruction manual carefully before using the product.

Please visit the RIX official website or the RIX mobile APP to view the latest product manuals





▼ TABLE OF CONTENTS

01

Overview ...02

02

Features ...02

03

Description ...03

04

In the box ...06

05

Appearance ...07

06

Installation ...09

07

Power Supply ...11

08

Buttons Operation ...14

09

Power On / Off ...18

10

Status Bar ...19

11

Shortcut Function ...20

12

Shortcut Menu ...24

13

Main Menu ...26

14

Firmware Update ...38

15

App Description ...38

16

Maintenance ...39

17

Troubleshooting ...40

18

Legal And Regulatory Information ...42

01 PRODUCT OVERVIEW

Designed by Hunters, for Hunters.

Introducing the DBH D12, the ultimate tool for hunting, observing, tracking and seeing at night. Equipped with cutting-edge thermal imaging technology and high-sensitivity infrared detectors, the DBH D12 ensures exceptional performance, even in challenging weather conditions like rain, snow, fog, and haze.

Built to excel in observation and geographic positioning, the DBH D12 boasts a versatile suite of features, including photography, video recording, laser rangefinder (LRF), a laser pointer, digital zoom, picture-in-picture (PIP), and recoil-activated video capture. Whether you're scouting, tracking, or documenting, the DBH D12 is designed to meet your every need in the field.

02 PRODUCT FEATURES

1280×1024 resolution	2560x2560 HD circular display
Threaded eye cup	3x-20x E-Zoom
Ballistic calculation long range precision can pair with a Kestrel	Integrated laser pointer

03 PRODUCT DESCRIPTION

Model	DBH D12
Sensor Specifications	
Type	VOx Uncooled
Resolution, pixels	1280×1024
Pixel Pitch, μm	12
NETD, mK	≤15
Frame Rate, Hz	50
Optical Specifications	
Optical Specifications	75 F1.0
Optical Zoom, x	3
Field of view, degrees	11.7×9.3
Digital zoom, x	3 to 20, stepped
Eye relief, mm	60
Diopter adjustment, D	-5 to +5
Detection range, yd	4260

03 PRODUCT DESCRIPTION

Model	DBH D12
Display Specifications	
Type	OLED
Resolution, pixels	2560 x 2560
LRF Specification	
Type, nm	905
Max Range, yd	1312
Wi-Fi	
Wireless Protocol	Wi-Fi
Frequency, GHz	2.4
Video Recorder	
Video / Photo Resolution, pixels	1280×1280
Video / Photo Format	.mp4/.bmp
Built-in Memory, GB	64

03 PRODUCT DESCRIPTION

Model	DBH D12
Physical Specification	
Degree of Protection, IP code	IP67
Operating Temperature Range, °F	-4 to +122
Weight, lb	3.47
Dimensions, inch	10.3×3×4.2
Connections and Compatibility	
Battery Type	18650×2
Operating time (at t=72 °F), h	7
Max.Recoil, g / Joules	1000 / 6000
Ballistic Calculation	Yes

04 IN THE BOX

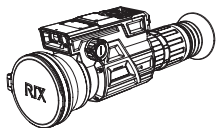

The DBH Series Thermal Imaging Device



Picatinny Mount



Package Bag



Eyepiece Hood



Thermal Target × 10

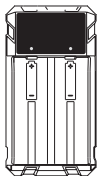

Battery Charger

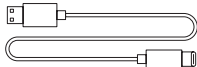

USB Type-C Cable



Battery × 4

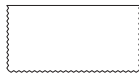

Lens Cloth



Hex Key



Screw × 6

05 PRODUCT APPEARANCE



05 PRODUCT APPEARANCE

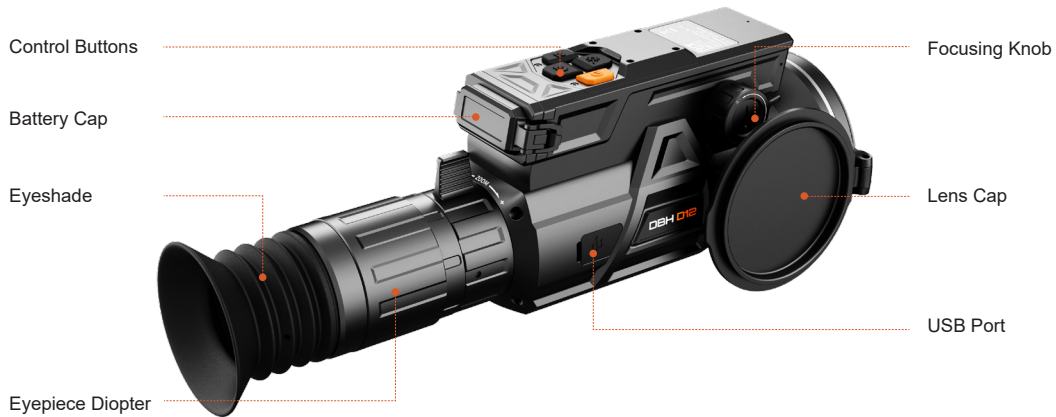

06 PRODUCT INSTALLATION

Please follow the schematic below for proper installation.

- » Before attempting to install your scope, please ensure that your firearm is unloaded and the muzzle is pointed in a safe direction.
- » Fasten the mount to the scope with three hex screws.
- » Unlock the mount. To do this, depress the lock button and swing the lever 90° to the open position.

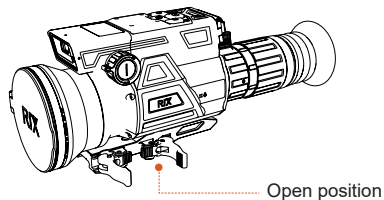
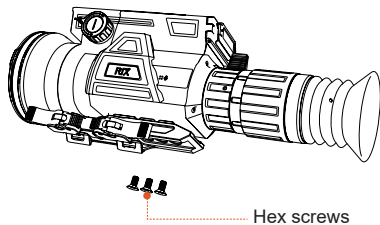

06 PRODUCT INSTALLATION

- » Install the assembly onto the rail and move the lever to the locked position.
- » Check the tension to close. The correct amount of tension is the maximum amount you apply with one hand to move the lever to a closed position.
- » To adjust the tension, move the lever to the open position and use a coin or other tools to rotate the nut to make the necessary adjustment. This process may take a few tries to get it where you want it.

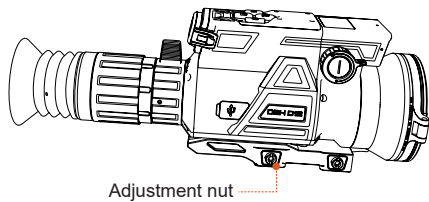
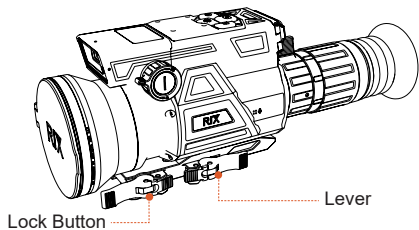

07 POWER SUPPLY

The DBH D12 is powered by two 18650 replaceable batteries.

- » Open the Battery Compartment: Press the lock to release and open the battery compartment cover.
- » Insert Batteries: Place the batteries into the compartment, ensuring the positive (+) ends face inward and the negative (-) ends face outward.
- » Secure the Compartment: Align the hook on the clasp and firmly press the battery compartment cover until it clicks into place, ensuring it is securely locked.

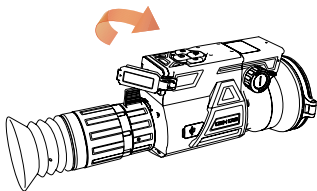

Step 1

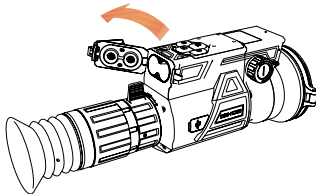

Step 2

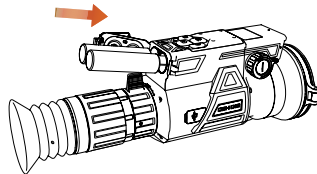

Step 3

07 POWER SUPPLY

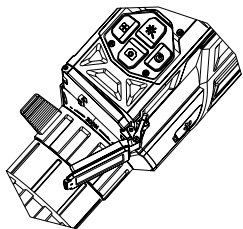

As shown in the figure, place the pull ring in position first, then fasten the battery compartment cover tightly. Avoid contact between the pull ring and the hook to prevent breakage caused by excessive fastening force.

WARNING

- » Do not charge or use if the protective cover is damaged.
- » Do not disassemble, impact, crush, throw or pierce the cell.
- » Do not short circuit the cell or throw it into water or fire.
- » Only use the charging method specified by the manufacturer.
- » Do not store it in a high temperature environment.

NOTE

- » Battery Orientation: The batteries can be inserted into the compartment in any direction, though it is recommended to place the positive (+) poles inward for optimal performance.
- » Battery Maintenance: Remove the batteries if the device will not be used for an extended period. Always ensure the device is completely powered off before removing or replacing the batteries. Avoid using modified or damaged batteries, as they may cause malfunctions or damage to the device.
- » Temperature Considerations: A decrease in battery capacity under sub-zero temperatures is normal and not a factory defect. Using the battery at temperatures above 122°F can reduce its lifespan.
- » Real-Time Clock (RTC): If the device is not used for an extended period, the RTC will reset. When the device is powered back on, the RTC battery will automatically recharge.

08 BUTTONS OPERATION

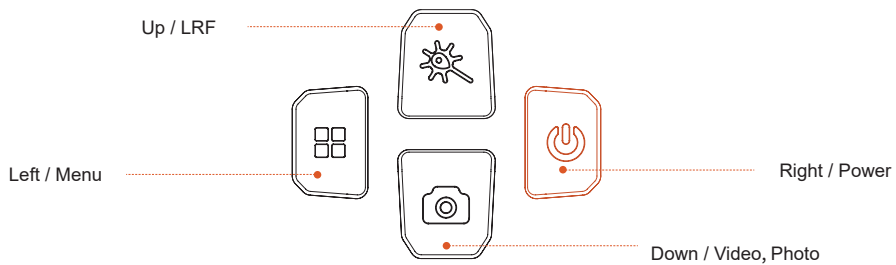

08 **BUTTONS OPERATION**

Current State	Button	Short Press	Press and hold
Powered off	Right	-	Power on the device
Standby	Right	Wake up the device	Wake up the device
Power on	Right	Standby	Shut down
Home interface	Up	Start / Stop distance ranging	Power on / off the LRF
	Left	Open the shortcut menu	Open the main menu
	Down	Start / Stop video recording	Take a photo
	Up+Left	Power on / off laser pointer	-
	Up+Down	Shutter	-
	Up+Right	Ballistic calculation on / off	
Shortcut menu interface	Up	Switch options	-
	Left	Adjust parameters	-

08 **BUTTONS OPERATION**

Current State	Button	Short Press	Press and hold
Shortcut menu interface	Right	Return to the home interface with saved changes	Shut down
	Down	Switch options	-
Main menu interface	Up	Switch options	-
	Left	Enter / Confirm	-
	Right	Return to the home interface with saved changes	Shut down
	Down	Switch options	-
Playback interface	Up	Rewind the video	Rewind the video continuously
	Left	Start / pause playback	Exit playback interface
	Right	Return to the home interface with saved changes	Shut down

08 **BUTTONS** OPERATION

Current State	Button	Short Press	Press and hold
Playback interface	Down	Fast-forward the video	Fast-forward the video continuously
Reticle moving interface	Up	Move reticle up / left slowly	Move reticle up / left quickly
	Left	Confirm	
	Right	Return to the home interface with saved changes	Shut down
	Down	Move reticle down / right slowly	Move reticle down/right quickly
Bad pixel correction interface	Up	Move reticle up / left slowly	Move reticle up / left quickly
	Left	Fix / Auto / Save bad pixel	Change direction of movement
	Right	Return to the home interface	Shut down
	Down	Move reticle down/right slowly	Move reticle down/right quickly

09 POWER ON / OFF

Power On

1. Open the objective lens cap.
2. Press and hold the Power button for 3 seconds until the RIX logo appears on the screen.



Power Off

1. Press and hold the Power button to open the power-off interface.
2. Wait for the 3-second countdown to finish; the device will then shut down completely.

10 STATUS BAR

The status bar is located at the bottom of the screen and displays the status of the scope, from left to right:



1	Zeroing distance: Indicates the active zeroing distance.	7	SD Card Status: Displays when the SD card is full (less than 500MB of capacity remaining).
2	Current Magnification: Displays the magnification level (e.g., 3.0x).	8	Wi-Fi: Indicates Wi-Fi connection status.
3	Palette: Indicates the active color mode (e.g., White Hot).	9	USB: Shows when the USB is connected.
4	Shutter: Status of the device's shutter operation.	10	Battery Level: Green: ≥50%; Yellow: ≥10%; Red: <10%
5	Recoil-Activated Video: Shows whether this feature is active.	11	RTC (Real-Time Clock): Displays the device's clock settings.
6	Microphone: Indicates microphone status.		

11 SHORTCUT FUNCTION

Digital Zoom (Ring)

Rotate the ring to zoom in and out of the image. The status bar provides a real-time display of the corresponding magnification level as you adjust it.

LRF (Press Up button)

1. On the home interface, press and hold Up button to turn on the LRF.
2. Simply press the Up button to start ranging.

Warning

Avoid looking directly into the laser emission window to ensure safety.

11 SHORTCUT FUNCTION

Photo / Video (Press Down button)

Photo Taking

On the home interface, press and hold the Down button to take a photo. A camera icon will appear in the upper left corner of the screen to indicate the action.

Video Recording

On the home interface, press the Down button once to start recording a video. A prompt box showing the recording time in the format HH:MM:SS (hours:minutes:seconds) will appear in the upper left corner. Press the Down button again to stop and save the recording.



11 SHORTCUT FUNCTION

Note:

» Photos and videos are saved to the built-in memory card in the following formats:

Photos: YYYYMMDD_HHMMSS.bmp

Videos: YYYYMMDD_HHMMSS.mp4

» It is recommended to synchronize the device's date and time via the app before using photo or video mode.

» The maximum duration for a single video is 5 minutes. If a video exceeds this limit, the device will automatically start a new file for the remaining footage.

» To download photos or videos, turn on the device and connect it to a computer using the data cable. Open "My Computer" on your desktop, locate the device named "Media," and access the files. To free up storage, delete or transfer media files to an external storage device.

» Always turn off the device properly to prevent damage or corruption of video files.

SHORTCUT FUNCTION

Image Correction (Press Up+Down buttons)

If the image effect becomes worse, you can correct the image effect by pressing the Up and Down buttons.

Laser pointer (Press Up+Left buttons)

Press the Up and Left buttons simultaneously to enable or disable the laser pointer. When activated, a green box will appear on the screen to indicate the target point.

Warning

Avoid looking directly into the laser emission window to ensure safety.

Ballistic Calculation (Press Up+Right buttons)

Enable / disable the ballistic calculation. When enabled, a new marker will appear on the screen to indicate the target.

12 SHORTCUT MENU

On the home interface, press the Left button to open the shortcut menu. Press Up or Down to switch the options, and press Left button to change the setting.

12 SHORTCUT MENU

Scene Settings

Press the Left button to switch between scene modes, which range from 1 to 4. Mode 1 is set as the default.

Palette Settings

Press the Left button to switch palette, and choose from white hot, black hot, red hot, red monochrome, green monochrome. White hot is set as the default.

Brightness Settings

Press the Left button to switch image brightness, with a range of 1-10 and 5 as the default.

Contrast Settings

Press the Left button to switch image contrast, with a range of 1-10 and 5 as the default.

Enhance Settings

Press the Left button to switch image enhancement, with a range of 1-5 and 3 as the default.



13 MAIN MENU

On the home interface, press and hold the Left button to open the main menu. The menu consists of two pages, which can be navigated using the Up or Down button.

Page 1 of the Main Menu

PIP (Picture-in-Picture)

Press the Left button to enable or disable the PIP function. When enabled, the main digital zoom resets to 1x, while the PIP zoom adjusts via the ring.

When the PIP function is enabled, a small window appears on the upper part of the display, magnifying the selected area. This allows users to easily observe target details.

Users can change the type and color of the PIP reticle through menu options.

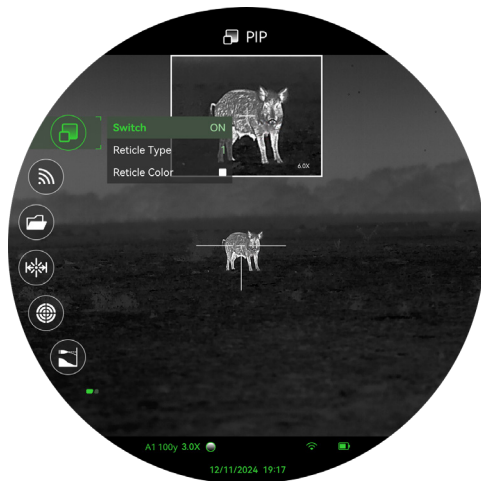

Wi-Fi

Press the Left button to toggle the Wi-Fi function. The device can connect to a mobile phone via Wi-Fi. Search for the Wi-Fi network named "DBH D12-xxx" (where "xxx" is the device's serial number) on your phone. Select the network and enter the default password, 12345678, to connect.

Note

The DBH D12 allows customization of the Wi-Fi name and password through the app. To do this, access the Device Parameter interface, and enter a new Wi-Fi name (SSID) and password in the provided text box, submit the changes, and reconnect using the updated credentials.

File

The file interface allows users to manage images and videos stored on the device efficiently.

- Image: Users can view images in full-screen mode and delete them if necessary.
- Video: Users can play, pause, fast forward, rewind, or delete videos directly from the interface.

LRF (Laser Range Finder)

Easily switch between measurement modes with the Left button:

- Single Mode: Press the Up button once to perform a single distance measurement.
- Continuous Mode: Press the Up button to start continuous distance measurement and press it again to stop.
- Users can change the type and color of the LRF reticle through menu options.



Reticle

Reticle Type

Press the Left button to switch reticle type, with a total of 8 reticle type options available.

Reticle Color

Press the Left button to switch reticle color, with a total of 8 reticle color options available.

Reticle Brightness

Press the Left button to switch reticle brightness, with a range of 1-3 and 3 as the default.



13 MAIN MENU

Reticle Zeroing

Users can move the reticle positions and quickly center it through this menu. At the same time, the screen can be frozen to make the movement of the reticle more accurate. When you finish moving and exit the zeroing menu, the zeroing data is saved.

Profile	A
X	+200
Y	+200
Zero	
Freeze	
Exit	

Ballistic Calculation

The scope offers five types of ballistic markers. When the ballistic calculation function is enabled, users can input ballistic parameters and perform calculations. Once calculated, the screen will display the marker and result. We have provided five sets of profiles for users to use in different scenarios. These parameters can also be accessed via the mobile app.

When the LRF is activated, in single mode, a new result will be calculated based on the measured distance each time, and the reticle will move to the new position. In continuous mode, the distance measurement needs to be stopped first, and then the scope will calculate based on the last measurement result.



Page 2 of the Main Menu

Microphone

Press the Left button to enable or disable the microphone. When enabled, the device captures ambient sound while video recording.

Recoil Activated Video (RAV)

Switch

Press the Left button to enable or disable the RAV function. When enabled, the device automatically records video before and after a recoil event, allowing users to easily capture critical moments.

Time before recoil

Press the Left button to set the pre-recoil recording duration. Options include 5 seconds (default), 10 seconds, and 15 seconds.

Time after recoil

Press the Left button to set the post-recoil recording duration. Options include 5 seconds (default), 10 seconds, and 15 seconds.

Note

To prevent video file corruption, always ensure the device is powered off properly.

Anemometer

Press the Left button to enable or disable the anemometer. The anemometer connects via Bluetooth. When enabled, the scope will automatically search for nearby anemometers, indicated by a flashing icon. At this point, turn on the anemometer's Bluetooth switch, and the system will connect automatically. Once the connection is established, the icon will stop flashing, and the wind speed value will appear.

Note

The scope can only be paired with a Kestrel anemometer.

13 MAIN MENU

Settings

External Video

When enabled, users can view the device's image output on a connected computer.

Auto Shutter

When enable, the scope will automatically perform shutter correction.

Date&Time

Users can modify the system's date and time settings. The updated system time will be reflected in the timestamps of photos and videos.

Factory Reset

The device will reset all parameters and settings, and automatically reboot.

External Video	OFF
Auto Shutter	ON
Date&Time	>
Factory Reset	>
USB	USB1
Information	>
Memory	>
Exit	

13 MAIN MENU

USB

Developer debugging interface.

Information

Show the device information, such as PN, SN, Software.

13 MAIN MENU

Memory

The memory interface displays the remaining storage capacity. Users can format the memory and enable the auto-reboot function as needed.

Warning

During a factory reset or memory formatting, ensure the device is not connected to a computer and has at least 50% battery power. Avoid pressing any buttons or shutting down the device until it reboots automatically.

Bad Pixel Correction

When using the device, you may notice pixel defects, such as stable bright or dark spots. The bad pixel correction function allows you to remove these defects.

On the bad pixel correction interface:

- Press the Up or Down button to move the reticle.
 - Press and hold the Left button to switch the reticle direction.
 - Press the Left button to perform the desired operation.
- 1.Fix: Press Left button to fix the pointed pixel.
 - 2.Auto: The device automatically searches for bad pixels and automatically fixes them.
 - 3.Save: Press Left button to save the result and exit the interface.
 - 4.Exit: Press Left button to not save the result and exit the interface.

Laser Pointer

In addition to using the shortcut key to turn on the laser pointer, it can also be turned on or off through the menu options. At the same time, the type and color of the laser pointer reticle can also be adjusted.

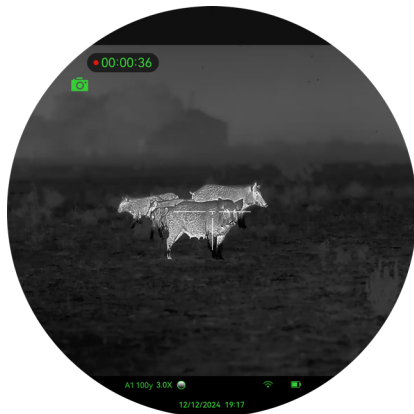

14 FIRMWARE UPDATE

Copy the firmware file to the device and reboot, it then detects the firmware file and updates.

15 APP DESCRIPTION

The DBH series comes with a dedicated app. By connecting the device to the app on a mobile phone, you can enjoy real-time image transmission. Download instructions for using the app from the official website (www.rixoptics.com).

Users have the option to update the firmware of the DBH product by utilizing the app or downloading the latest version from www.rixoptics.com.

You can download and install the app from the official website (www.rixoptics.com) or by searching RIX+ in an app store.

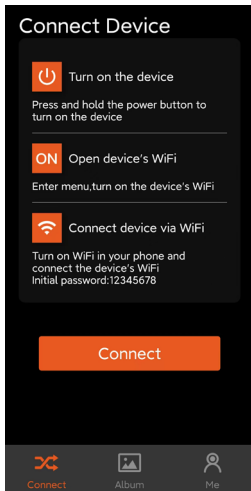

16 PRODUCT MAINTENANCE

Prior to using the device, it is important to conduct a thorough technical inspection to ensure the following items are in proper working condition.

To remove dust and dirt from the metal and plastic parts, use a cotton cloth and gently wipe the surface clean. Make sure that the 18650 battery being used is free from any bulges or deformities and that the plastic cover is undamaged.

17 PRODUCT TROUBLESHOOTING

Refer to the table below, which outlines potential issues that may arise during operation. For any product issues that cannot be remedied or are not listed below, please contact the RIX Optics customer support by visiting our website at www.rixoptics.com or call+1(800) 580-5281.

Fault	Possible Causes	Solutions
The device cannot be started.	The battery is out of charge	Charging
The image quality is poor or the detection range shortens.	These problems are likely to occur when you use the device in harsh weather such as snow, rain and fog.	

17 PRODUCT TROUBLESHOOTING

Fault	Possible Causes	Solutions
The device cannot connect to a mobile phone.	The Wi-Fi password is incorrect.	Enter the correct password
	There are too many Wi-Fi networks in the range of the device, which may cause interference.	For a stable network connection, it is recommended to relocate the device to an area with a lower number of Wi-Fi networks
Wi-Fi signals are lost or interrupted.	The device is beyond Wi-Fi coverage. There is blocking (such as concrete walls) between the device and the receiver	Move the device to a place where you can receive Wi-Fi signals.
When the device is used at a low temperature, the imaging quality is poorer than that at a normal temperature.	At temperatures above 0°C, the temperature rise of observed objects (environment and background) varies due to different thermal conductivity coefficients. As a result, high-temperature contrast occurs and the image quality is better. At low temperatures, the observed targets (background) usually cool down to a similar temperature because of reduced temperature contrast. Therefore, the image quality (details in particular) is poor which is a characteristic of thermal imaging devices.	

Wireless Transmitter Module Frequency Range

Frequency Range	802.11b/g/n-20MHz: 2.412GHz-2.462GHz
Channel Number	802.11b/g/n-20MHz: 11
Transfer Rate	802.11b: 11/5.5/2/1 Mbps 802.11g: 54/48/36/24/18/12/9/6 Mbps 802.11n: up to 72.2Mbps
Modulation Type	DSSS (802.11b),OFDM(802.11g/n)
Wireless transmitter module power	<20dBm

BT

Frequency Range	2402MHz~2480MHz
Channel Number	79
Bit Rate of Transmitter	1/2/3Mbps
Modulation Type	GFSK, $\pi/4$ -DQPSK, 8DPSK
Antenna Type	Internal Antenna
Antenna Gain	0.83dBi

BLE

Frequency Range	2402MHz~2480MHz
Channel Number	40
Bit Rate of Transmitter	1Mbps
Modulation Type	GFSK
Antenna Type	Internal Antenna
Antenna Gain	0.83dBi

FCC Statement

FCC ID:2A7ZZ-DBH-04

Labeling Requirements

This device complies with part 15 of the FCC Rules. Operation is subject to the following two conditions:(1)This device may not cause harmful interference, and (2) this device must accept any interference received, including interference that may cause undesired operation.

Information To The User

Any Changes or modifications not expressly approved by the party responsible for compliance could void the user's authority to operate the equipment.

EMC Class B

Note: This equipment has been tested and found to comply with the limits for a Class B digital device, pursuant to part 15 of the FCC Rules. These limits are designed to provide reasonable protection against harmful interference in a residential installation. This equipment generates, uses and can radiate radio frequency energy and, if not installed and used in accordance with the instructions, may cause harmful interference to radio communications. However, there is no guarantee that interference will not occur in a particular installation. If this equipment does cause harmful interference to radio or television reception, which can be determined by turning the equipment off and on, the user is encouraged to try to correct the interference by one or more of the following measures:

- Reorient or relocate the receiving antenna.
- Increase the separation between the equipment and receiver.
- Connect the equipment into an outlet on a circuit different from that to which the receiver is connected.

18 LEGAL AND REGULATORY INFORMATION

—Consult the dealer or an experienced radio / TV technician for help.

To comply with RF exposure requirements, a minimum separation distance of 0.00 cm must be maintained between the user's body and the handset, including the antenna.

Laser Label





Tel: +1(800)580-5281

Web: www.rixoptics.com

Email: support@rix-nv.com

Addr.: 700 International Pkwy Ste 102, Richardson TX 75081